

LANE TECH SHEET

7 STEP POLY LADDER

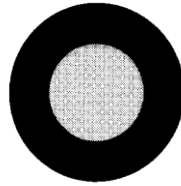

RAIL
9/16" Grade 60 Round Bar

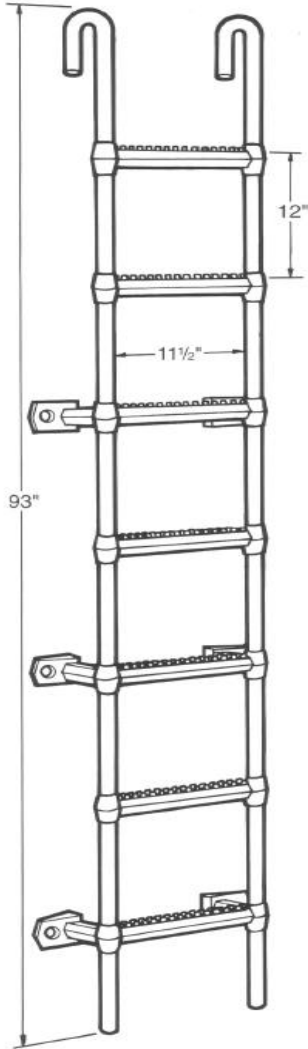
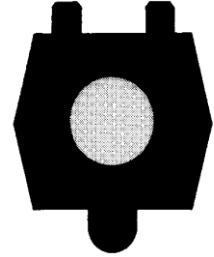

RUNG
1/2" Grade 60 Rebar

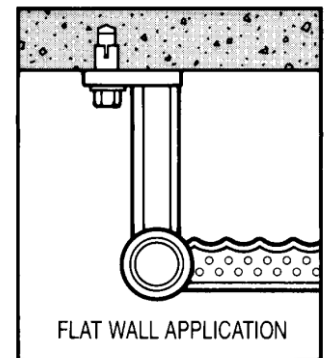
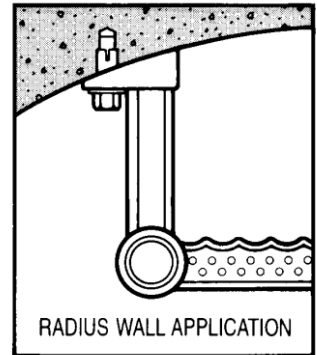
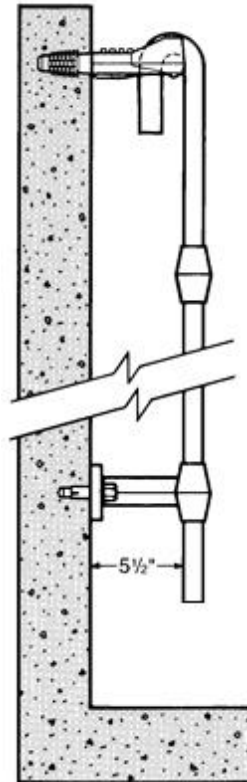

Polypropylene conforms to ASTM D-4101.
Ladders meet all ASTM C-497 load requirements.

Ladders to be fastened to wall with 1/2" x 2-3/4" wall anchors

Drawing: 1
Scale: None

7 Step Poly
Hanging Ladder
Part # PL-7

LANE INTERNATIONAL CORPORATION

P.O. Box 925 * Tualatin, OR 98062
503-692-9860 * www.laneinternational.com